

SE 100 GLT SmartKey Arming Device

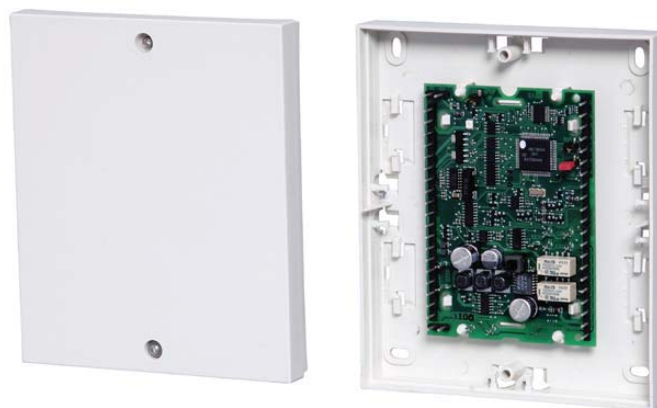

Security Systems

Installation Manual
EN SE 100 GLT



BOSCH

Table of Contents

Chapter	Page
System Description	
System Overview	3
Description of Connections on the SE 100 GLT Control Unit	4
Installation Instructions	
Installing System Components	8
Connecting System Components	10
Mechanical/Electrical Function Test	11
Programming for Operation	12
Installing Optional Components	14
Connecting the Control Panel and Optional Components	14
Operation Without Blocking Element	16
Operating the System	
Operation with 1 SmartKey, 1 Detection Area	17
Operation with Multiple SmartKeys, 1 detection Area.....	20
Disarming for "Forced Unlocking and Alarm Display"	23
Fault Elimination	
Problems with Installation and Reading In the Keys.....	24
Diagnostics Options on the Open Control Unit	24
Operating Problems During Normal Operation	25
Replacing the Bolt in the Blocking Element	26
Notes for Maintenance and Service	
General	27
Inspection and Maintenance	27
Loss of Keys	28
Loss of the Security Card.....	28
Ordering Additional Keys	29
Restoring the Default Settings	29
Technical Data	30

System Overview

The SE 100 GLT SmartKey arming device is a system solution for arming intrusion alarm systems. The individual components of the system can be put together as required for the intended usage. Operation types with and without blocking elements are possible.

Blocking element

The blocking element is an additional lock for the door and is meant to prevent unauthorized entry to an armed area. The blocking element is always installed in the armed area in conjunction with a kit to enable it to accommodate different doors (the figure below shows a door-mounted installation; see installing the blocking element for other variants).

Operation types with and without blocking elements are possible.

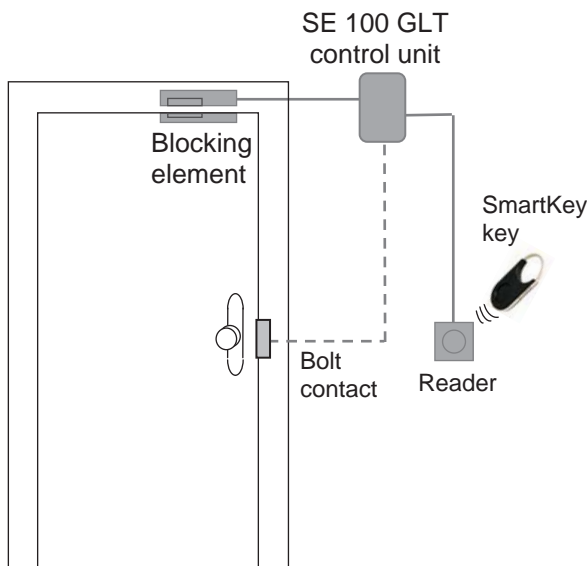

SE 100 GLT control unit

The control unit processes the status reports of all components in the system, communicates these reports to the intrusion alarm system and controls the blocking element. The control unit is installed in the secure area.

Reader

The system is armed and disarmed by holding an electronic key up to the reader. The LED and buzzer provide information about the status of the system as well as operation.

The reader can be surface mounted or recessed mounted (outside the secure area).

Bolt contact

A GLT bolt contact can be connected to the control unit. The bolt contact is not included in the scope of delivery.

Magnetic contact

A GLT standard magnetic contact can be connected to the control unit. The magnetic contact is not included in the scope of delivery.

SmartKey keys

There are two types of SmartKey keys

- Keys with a security card
- Standard key (without security card)

Key with security card: the system operates like a locking device. The key kit consists of a set number of valid keys and a security card. The control unit is initialized using the security card, and accepts only the keys of the key kit. To order additional keys, the security card must be sent to the manufacturer together with the order. The keys are labeled with a consecutive key number, a security card number and an 8-digit identification number.

Standard key (without security card): the keys are not numbered and can be programmed in any way. The keys are labeled with an 8-digit identification number.

System Description

Description of Connections on the SE 100 GLT Control Unit

The control unit connections have different functions. There are inputs, outputs and plug-in terminals. Inputs and outputs have to be assigned according to a specific schema with regard to the scope of basic functions. The exception is connection 10, which is for activating an optional function (see explanations on the following pages).

Control unit

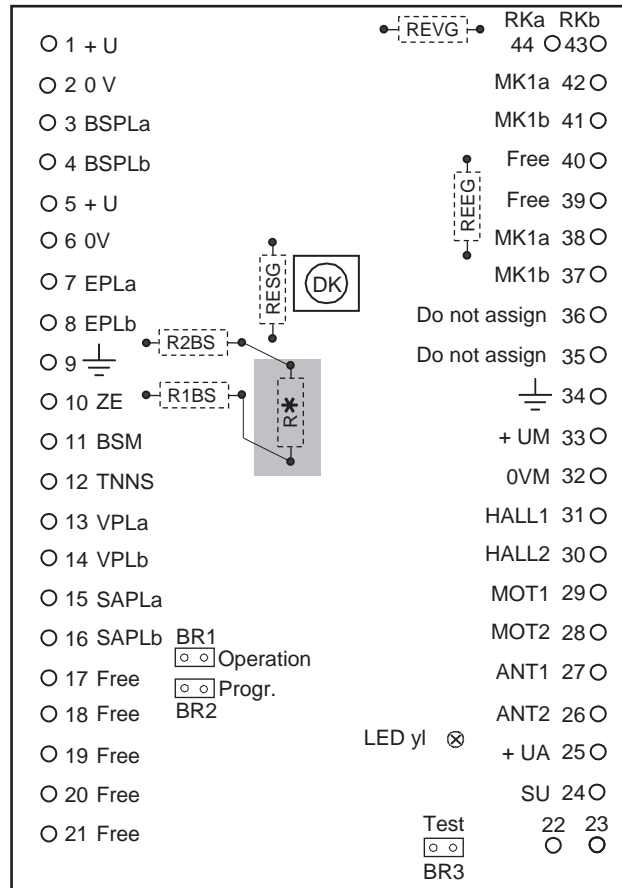

- REVG = terminating resistor, locking group
- REEG = terminating resistor, intrusion detector group
- RESG = terminating resistor, tamper group
- R2BS = block type lock group resistor (disarmed)
- R1BS = resistor parallel to R2BS (block type lock group armed)
- R*** = for alternative assignment instead of R2BS (see next page)

System Description

Description of the Connections on the Control Unit

Connection	Name	Function	Description
1	+ U	Input	Power supply 10.8 - 30 V
2	0 V	Input	Power supply 0 V
3/4	BSPLa/ BSPLb	Output	<p>Block type lock</p> <p>Alternative resistor installation</p> <p>with R* instead of R2BS</p>
5	+U	Distributor	External power supply 10.8 - 30 V Supplies additional components
6	0 V	Distributor	External power supply 0 V Supplies additional components
7/8	EPLa/EPLb	Distributor	<p>Connection option for an EMA intrusion detector group incl. soldering points for the terminating resistor (REEG)</p> <p>e.g. magnetic contact</p>
9	Ground	Distributor	Operating ground
10	ZE	Input	<p>Optional function "Forced unlocking and alarm display" (not required for basic functionality): Unlocks the blocking element in the event of an external alarm and activates the red flashing LED on the reader after disarming has occurred.</p> <p>Function is activated when the input is set to 0 V.</p>

System Description

Description of the Connections on the Control Unit

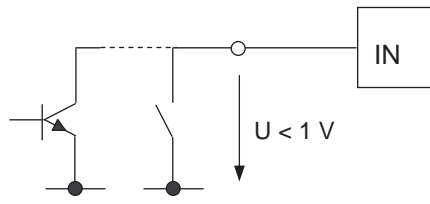
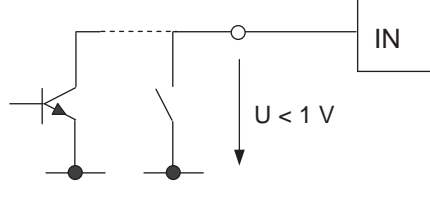
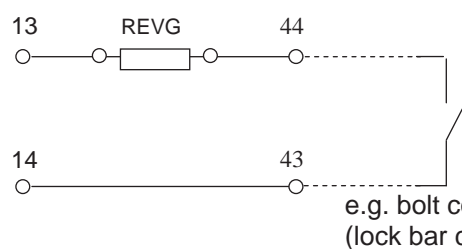
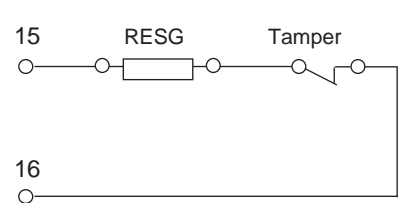
Connection	Name	Function	Description
11	BSM	Input	<p>"Block type lock magnet" or forced actuation system, i.e. the EMA is ready to activate.</p>  <p>Input must be switched to 0 V to enable arming. Input must not be activated for disarming.</p>
12	TNNS	Input	<p>Confirming when armed</p>  <p>The input must be switched to 0 V when armed. Do not activate the input when the system is disarmed.</p>
13/14	VPLa/VPLb	Distributor	<p>Connection option for an EMA locking group incl. soldering points for the terminating resistor (REVG).</p>  <p>e.g. bolt contact (lock bar contact)</p>
15/ 16	SAPLa/ SAPLb	Distributor	<p>Connection option for a tamper group incl. soldering points for the terminating resistor (RESG).</p> 
17- 21	Free	Distributor	Plug-in terminals

System Description

Description of the Connections on the Control Unit

Connection	Name	Function	Description
44/43	VPLa/VPLb	Distributor	Connection option for bolt contact (see connection 13/14)
42/41	MK1a/MK1b	Distributor	Connection option for magnetic contact (see connection 7/8)
40/39	Free	Distributor	Free plug-in terminals (preferably for connecting a second magnetic contact)
38/37	EPLa/EPLb	Distributor	Connection option for magnetic contact (see connection 7/8)
36/35	Blocked	No function	Do not wire or connect!
34	Ground	Distributor	Operating ground
33	+UM	Output	Power supply 12 V of the blocking element
32	0 VM	Output	Power supply 0 V for the blocking element
31	HALL1	Input	Detection of final bolt position
30	HALL2	Input	Detection of initial bolt position
29/28	MOT1/MOT2	Output	Blocking element motor control
27/26	ANT1/ANT1	Input	Antenna
25	+UA	Output	Power supply 12 V of the reader
24	Su	Output	Buzzer
23	LED green	Output	Green LED
22	LED red	Output	Red LED

Note:

The control unit provides connection options and bases for the terminal resistance of magnetic contacts or a bolt contact, therefore dispensing with the need for an additional distributor for these components.

However, as magnetic or bolt contacts are not components of the SmartKey system, they are not evaluated by the control unit.

Installation Instructions

Installing System Components



Note the following during installation:

Used shielded cables only.

- The usual precautionary measures for C-MOS technology apply to handling the circuit boards and to soldering work. Wear a grounded wrist strap when working on the control panel.
- Please refer and adhere to the following table with regard to cable lengths:

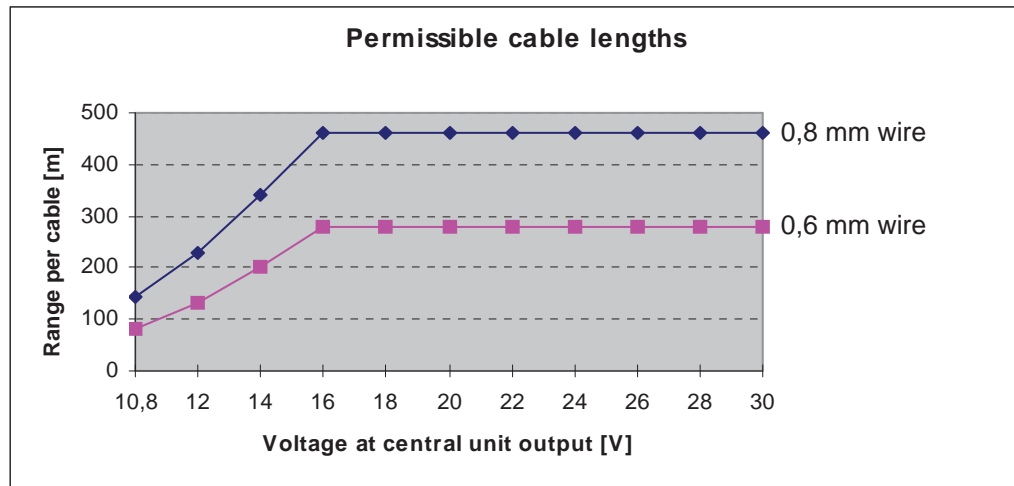

Mounting the control unit

Mount the control unit to the wall. When choosing a position to mount the unit,



please note that the reader and blocking element are equipped with a 6 m molded cable which must not be lengthened.

Mounting the reader

Mount the reader according to the enclosed instruction leaflet.



The reader should be installed at a height of at least 1.2 m and preferably recessed mounted. The reader is molded and completely resistant to environmental influences. Do not fit the reader cover until you have performed all the function tests. Removing the cover after it has been fitted will cause damage to the cover.

Installation Instructions

Installing the blocking element

Install the blocking element using the appropriate kit and according to the enclosed installation instructions.



Make sure the door cannot slam shut. The bolt on the blocking element could otherwise be damaged during start-up by a slamming door.

Blocking element variants and kits

Installation on the door or on the frame

Kit for on-the-door installation. In the kit, a conventional magnet contact can be used.

Bolt piece (installed on the frame)

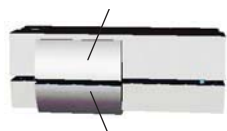

Sleeve piece (installed on the door)

Kit for glass doors

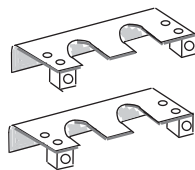

Installation on the door or on the frame

Bushing Normal collar Angled collar



Counterpiece

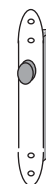

Installation example:

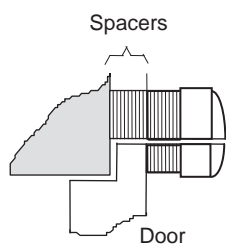

Installation example:

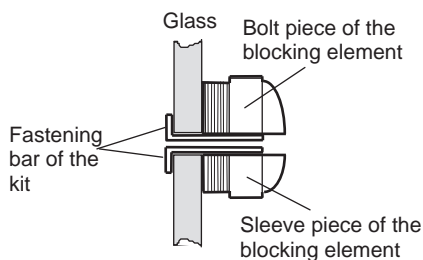

Installation example:

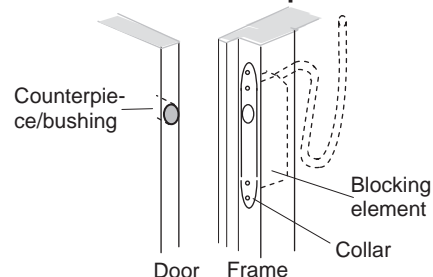

Installation Instructions

Connecting System Components



Note the following when connecting electrical components:

- Do not perform any connection work until you have disconnected the power supply. Make sure the control panel is disconnected from the power supply.
- When you have completed the wiring work **do not** fit the control unit and reader covers until all function tests have been performed.

Wiring the blocking unit, reader and power supply.

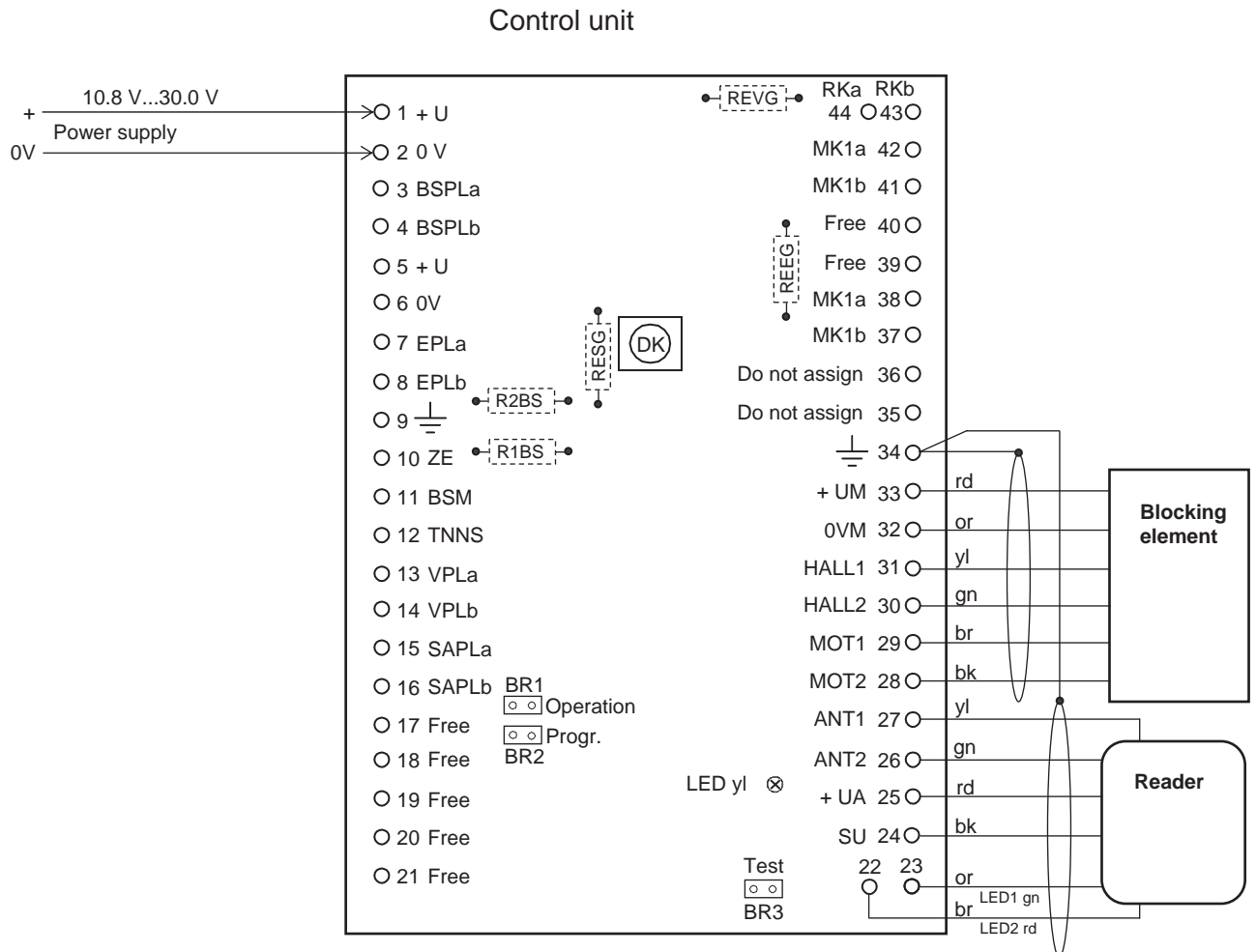

Installation Instructions

Mechanical/Electrical Function Test

This function test checks the mechanical and electrical functioning of all LEDs, the reader's buzzer and the bolt on the blocking element; it does not test arming/disarming the system.

Switching on the power supply

Make sure that bridge BR1 on the control unit is connected before switching on the power supply.

- Switch on the power supply. The yellow LED on the control unit's circuit board and the red LED on the reader are both activated. All signals from the yellow LED are therefore also available on the reader.

The yellow LED on the control unit indicates the system's status as follows:

Yellow LED	Status	Required action
Off	System is OK	None
On	Electronic defect	<ul style="list-style-type: none">• Switch the power supply off and then back on. Replace the control unit if the LED is still on.
2 flashes	Antenna malfunction	<ul style="list-style-type: none">• Check that the reader is connected correctly.• Switch the power supply off and then back on. Replace the reader if the LED continues to flash.

Function test

1. On the control unit, remove the jumper from BR1 and plug it into BR3.
 - ➔ The blocking element bolt engages.
 - ➔ The red and green LEDs on the reader light up.
 - ➔ The reader buzzer sounds for 5 seconds.
2. On the control unit, remove the jumper from BR3.
 - ➔ The blocking element bolt disengages.
 - ➔ The red and green LEDs on the reader go off.
3. Repeat steps 1 - 2 with the door closed to check the precise insertion of the blocking element's bolt into the bolt-hole.
4. Once you have completed the function test, plug the jumper back into BR1.
 - ➔ The yellow LED on the control unit's circuit board indicates the system's status as follows:

Yellow LED	Status	Required action
Off	System is OK	None
1 flash	Bolt will not engage	<ul style="list-style-type: none">• Check that the blocking element and bolt-hole are correctly installed and connected to the power supply.• Repeat the test.

5. Now fit the reader cover as shown in the installation notes.
6. **Do not fit the control unit cover** at this stage.

Installation Instructions

Programming for Operation

Keys are read in depending on the type of key: "Key with security card" or "Standard key (without security card)".

Reading in the key with security card

- Reading in the security card: this replaces the manufacturer's standard code with the customer's individual code.
- Reading in the key (max. 16): this step communicates information on the keys to the system.

Reading in the security card

1. Connect the jumper on the control unit's circuit board to BR2.

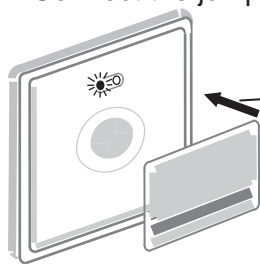

2. Hold the front **or** the reverse side of the security card parallel to the reader at a maximum distance of 2 cm until the red LED lights up and you hear a confirmation signal.

➔ This completes reading in the security card.

Reading in the key

3. Press and hold the key button on the first key to be programmed and hold the key up to the circle in the middle of the reader at a maximum distance of 2 cm until you hear a short confirmation signal.

4. Repeat step 3 for all the other keys that require programming. The flashing signals on the control unit's yellow LED and the reader's red LED correspond with the number of programmed keys.

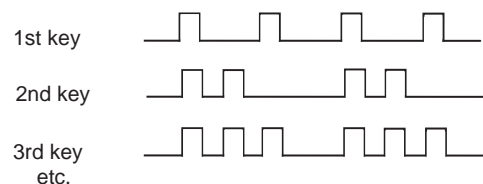

5. Plug the jumper back into BR1.

➔ The yellow LED on the control unit and the red LED on the reader go out. This completes programming the keys.

Installation Instructions

Reading in standard keys (without security card)

Reading the standard key into the reader replaces the manufacturer's standard works code with the standard key's code.

A maximum of 16 standard keys can be used for each system.

Reading in the key

1. Connect the jumper on the control unit's circuit board to BR2.

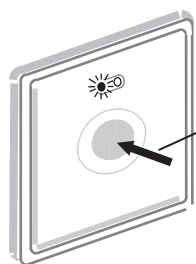

2. Press and hold the key button on any of the standard keys and hold the key up to the circle in the middle of the reader at a maximum distance of 2 cm until the red LED flashes and you hear two short confirmation signals.

➔ This completes reading in the standard key.

3. Press and hold the key button on the remaining keys and hold them up to the circle in the middle of the reader at a maximum distance of 2 cm until you hear a short confirmation signal.

The flashing signals of the control unit's yellow LED and the reader's red LED correspond with the number of keys.

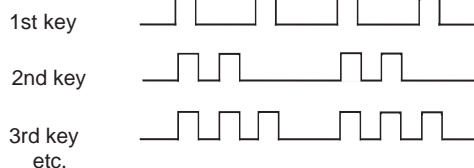

4. Connect the jumper back into BR1.

➔ The yellow LED on the control unit and the red LED on the reader go out. This completes programming the keys.

Installation Instructions

Installing Optional Components

Install optional components such as magnetic contacts or bolt contacts according to the manufacturer's instructions. Although these components are not part of the SmartKey system, they can nonetheless be connected to the control unit. The control unit will serve as a distributor.

Connecting the Control Panel and Optional Components

1. Connect the control unit to the control panel.



Make sure the power supply to the control panel is disconnected before you connect the control unit to the control panel.

2. Connect the optional components as per connection diagram.
3. Solder the terminating resistors according to your control panel configuration.

See also the description of connections from page 5 onwards.

Concluding system installation

When you have finished all the connections:

1. Make sure that for normal operation bridge BR1 is connected in the control unit.
2. Fit the cover to the control unit.
3. Make sure the red and green LEDs on the reader are off (= normal operating condition).
4. Arm and disarm the system once with each key (see Operating the System) check that they have been programmed correctly. Inform the operator of this step in advance to avoid any unnecessary interruption of operations.

Installation Instructions

Connecting the Control Panel and Optional Components

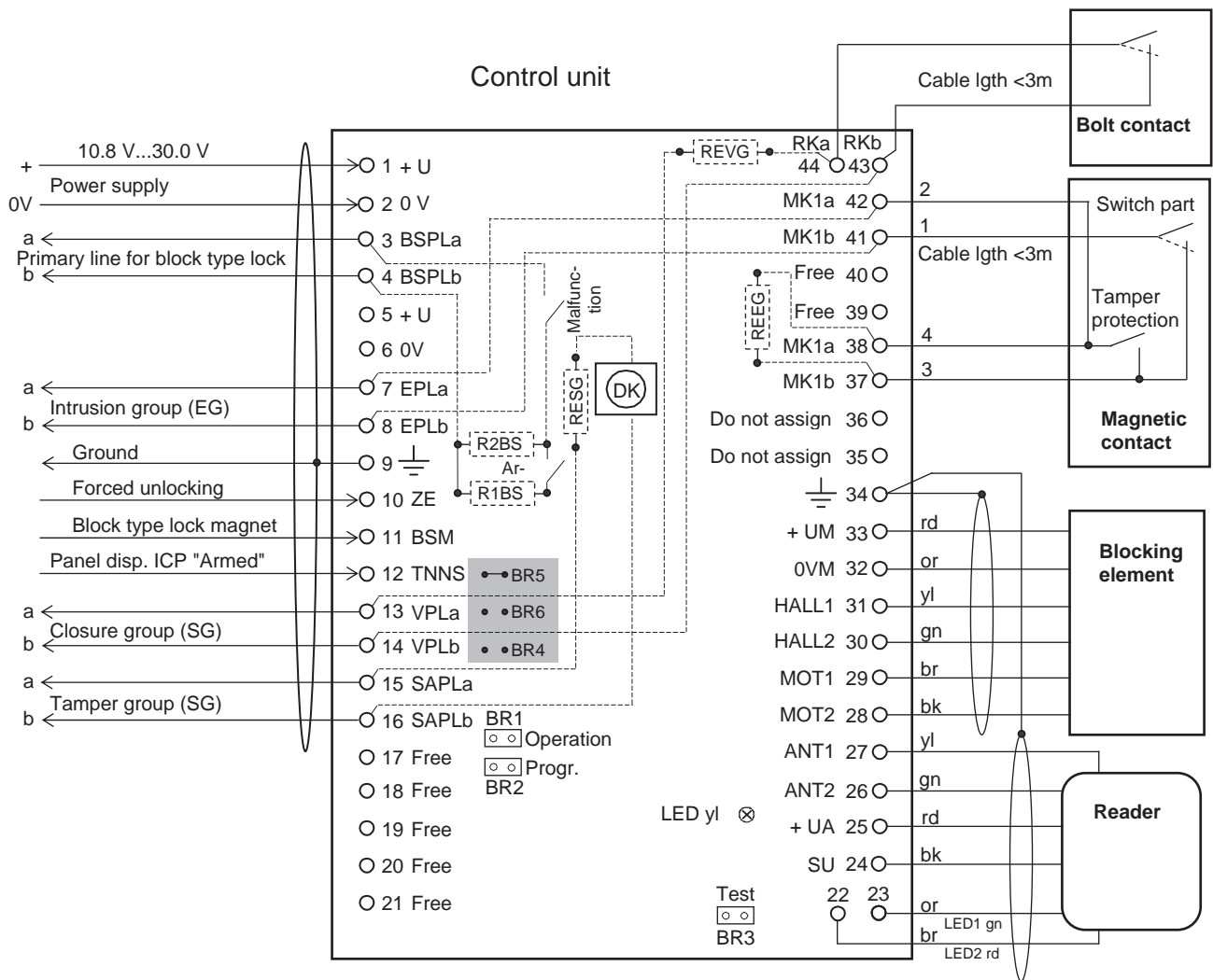

If necessary, change the soldering bridges on the reverse side of the circuit board before connecting the control panel and components.



Connection to conventional control panels = delivery state
 Soldering bridge 5 connected (BSM signal = negative)
 Soldering bridge 6 open
 Soldering bridge 4 not used



Connection to NVK 100 LSN
 Soldering bridge 5 open (BSM signal = positive)
 Soldering bridge 6 connected
 Soldering bridge 4 not used

Installation Instructions

Operation Without Blocking Element

Use the following switching arrangement on the control unit to set the operating mode "Without blocking element". Connect the inputs HALL1 and HALL2 to 0 V.

Control unit

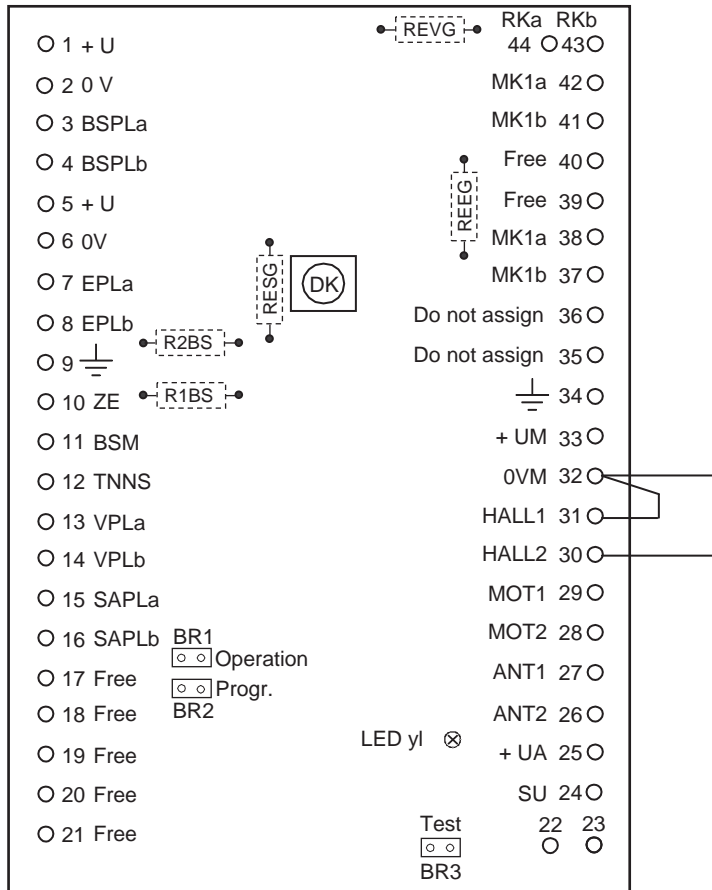

Note:

The blocking element is automatically removed from the forced actuation system check as soon as the control unit has established that no blocking element is connected to the system.

Operation with 1 SmartKey, 1 Detection Area

When operating the system, every operation process and the current system status are indicated by the two LEDs and the buzzer on the reader.

The following schema applies to the signaling behavior of these display elements for 1 SmartKey system per detection area:

Display element	Behavior	Meaning
Green LED	Lit	System disarmed
	Flashing	System is attempting to disarm
Red LED	Lit	System is armed
	Flashing	System is attempting to arm
Buzzer	Short signal for 0.5 sec.	Process initiated
	Short signal for 2.5 sec.	Process completed successfully
	Interval signal for 5 sec.	Process not completed successfully

Viewing the system status

Press and hold the key button and hold the key up to the reader for 1 second. The system status is indicated as shown in the table above.

Operating the System

Operation with 1 SmartKey, 1 Detection Area

Arming

Press and hold the key button and hold the key up to the reader for 3 seconds until you hear a short signal from the buzzer.

- ➔ The green LED starts to light up, signaling that the system is currently disarmed.
- ➔ The red LED starts to flash, signaling that the arming process has commenced.

- ➔ The green LED is deactivated.
- ➔ The red LED and the buzzer are activated for 2.5 seconds (continuous signal).

System arming successful.

- ➔ The red LED is deactivated.
- ➔ The green LED lights up for 5 seconds.
- ➔ The buzzer simultaneously emits an interval signal for 5 seconds.

System arming unsuccessful.

See the table "Operating Problems During Normal Operation" for assistance.

Process diagram for arming the system

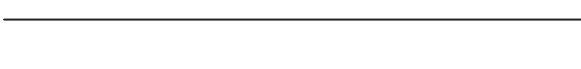
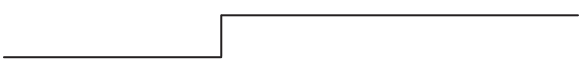
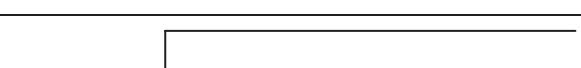
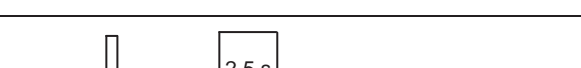
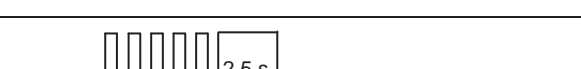
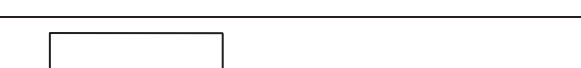
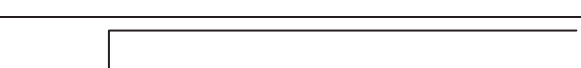
Key	To reader ---	
BSM	Ready to activate ---	
TNNS	Detection area armed Detection area disarmed	
BSL	Armed Disarmed	
Buzzer	On Off	
Red LED	On Off	
Green LED	On Off	
Bolt	Engaged Disengaged	

Operation with 1 SmartKey, 1 detection area

Disarming

Press and hold the key button and hold the key up to the reader for 3 seconds until you hear a short signal from the buzzer.

- ➔ The red LED is activated, signaling that the system is currently armed.
- ➔ The green LED starts to flash, signaling that the disarming process has commenced.

- ➔ The red LED is deactivated.
- ➔ The green LED and the buzzer are activated for 2.5 seconds (continuous signal).







Disarming was successful.

- ➔ The green LED is deactivated.
- ➔ The red LED is activated for 5 seconds.
- ➔ The buzzer will simultaneously emit an interval signal for 5 seconds.

Disarming was unsuccessful.

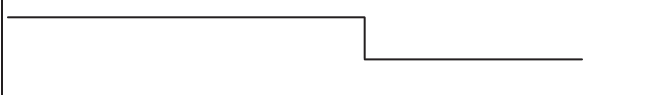
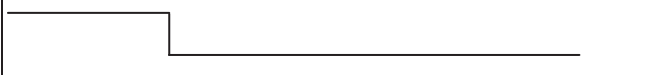
See the table "Operating Problems During Normal Operation" for assistance.

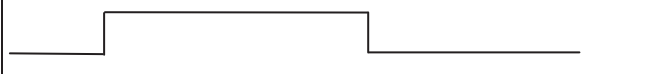
Process diagram for disarming

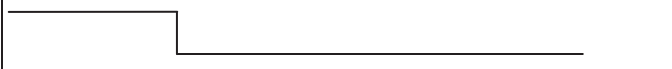
Key	To reader ---	
BSM	Ready to activate ---	
TNNS	Detection area armed Detection area disarmed	
BSL	Armed Disarmed	
Buzzer	On Off	
Red LED	On Off	
Green LED	On Off	
Bolt	Engaged Disengaged	

Operating the System

Operation with Multiple SmartKeys, 1 Detection Area

When operating the system, every operation process and the current system status are indicated by the two LEDs and the buzzer on the reader.

The following signaling behavior schema applies if multiple SmartKey systems in one detection area are **logically AND linked**. Logically AND linked means that a detection area is only armed if all the SmartKeys are also armed. A detection area is disarmed as soon as one SmartKey is disarmed. This performance characteristic must be implemented via the intrusion alarm system.

Display element	Behavior	Meaning
Green LED	Lit	Detection area disarmed
	Flashing	SmartKey is attempting to disarm
Red LED	Lit	Detection area armed
	Flashing	SmartKey is attempting to arm
Green and red LED	Both lit	SmartKey system is armed, detection area is disarmed.
Buzzer	Short signal for 0.5 sec.	Process initiated.
	Continuous signal for 2.5 sec.	Process completed successfully
	Interval signal for 5 sec.	Process not completed successfully

Viewing the system status

Press and hold the key button and hold the key up to the reader for 1 second. The system status is indicated as shown in the table above.

Operation with Multiple SmartKeys, 1 Detection Area

Arming (first and subsequent SmartKeys)

Press and hold the key button and hold the key up to the reader for 3 seconds until you hear a short signal from the buzzer.

- ➔ The green LED starts to light up, signaling that the system is currently disarmed.
- ➔ The red LED starts to flash, signaling that the arming process has commenced. Further signals (LED) follow as described in the left-hand box (arming successful) or in the right-hand box (arming unsuccessful).

- ➔ The red and green LEDs are activated for 2.5 seconds.
- ➔ The buzzer does not sound.

SmartKey arming was successful (detection area not yet armed).

You can now arm the next SmartKey.

- ➔ The red LED is deactivated.
- ➔ The green LED lights up for 5 seconds.
- ➔ The buzzer simultaneously emits an interval signal for 5 seconds.

SmartKey arming was unsuccessful. See the table "Operating Problems During Normal Operation" for assistance..

Arming (last SmartKey)

Press and hold the key button and hold the key up to the reader for 3 seconds until you hear a short signal from the buzzer.

- ➔ The green LED starts to light up, signaling that the system is currently disarmed.
- ➔ The red LED starts to flash, signaling that the arming process has commenced. Further signals (LED) follow as described in the left-hand box (arming successful) or in the right-hand box (arming unsuccessful).

- ➔ The green LED is deactivated.
- ➔ The red LED and the buzzer are activated for 2.5 seconds (continuous signal).

Arming of SmartKey and detection area successful.

- ➔ The red LED is deactivated.
- ➔ The green LED lights up for 5 seconds.
- ➔ The buzzer simultaneously emits an interval signal for 5 seconds.

Arming of SmartKey and detection area unsuccessful.

See the table "Operating Problems During Normal Operation" for assistance.

Operating the System

Operation with Multiple SmartKeys, 1 Detection Area

Disarming (first SmartKey)

Press and hold the key button and hold the key up to the reader for 3 seconds until you hear a short signal from the buzzer.

- ➔ The red LED is activated, signaling that the system is currently armed.
- ➔ The green LED starts to flash, i.e. disarming initiated; the red LED remains activated. Further signals (LED) follow as described in the left-hand box (disarming successful) or in the right-hand box (disarming unsuccessful).

- ➔ The red LED is deactivated.
- ➔ The green LED and the buzzer are activated for 2.5 seconds (continuous signal).

Disarming of SmartKey and detection area successful.

You can now disarm the next SmartKey.

- ➔ The green LED is deactivated.
- ➔ The red LED is activated for 5 seconds.
- ➔ The buzzer simultaneously emits an interval signal for 5 seconds.

Disarming of SmartKey and detection area unsuccessful. See the table "Operating Problems During Normal Operation" for assistance.

Disarming (subsequent and final SmartKey)

Press and hold the key button and hold the key up to the reader for 3 seconds until you hear a short signal from the buzzer.

- ➔ The red and green LEDs are activated, indicating that the detection area is disarmed but the SmartKey is still armed.
- ➔ The green LED starts to flash, i.e. disarming initiated; the red LED remains activated. Further signals (LED) follow as described in the left-hand box (disarming successful) or in the right-hand box (disarming unsuccessful).

- ➔ The red LED is deactivated.
- ➔ The green LED and the buzzer are activated for 2.5 seconds (continuous signal).

Disarming the SmartKey was successful.

- ➔ The red and green LEDs are activated for 2.5 seconds.
- ➔ The buzzer does not sound.

SmartKey disarming was unsuccessful. See the table "Operating Problems During Normal Operation" for assistance.

Disarming for "Forced Unlocking and Alarm Display"



If this feature is active, i.e. the ZE function has been activated (see chapter "Description of Connections in the Control Unit"), please observe the following during disarming:

If the red LED on the reader flashes continuously after disarming, it means that the SmartKey is signaling an intrusion alarm. It is recommendable to have a procedure in place to protect the operator, e.g.: do not enter the area, call the alarm company or the police, etc. The red LED will be deactivated when the intrusion alarm system is reset.

Fault Elimination

Problems During Installation and Programming

Always check the following first of all:

- Are the component cables correctly connected?
- Are there any short-circuits/broken wires?
- Is the component connected to a power supply?
- Is the bridge BR1 connected correctly on the control unit?

Problem	Possible cause(s)	Elimination
LED on input/control unit is not activated during function test.	Component damaged during transportation, incorrect handling, etc).	Component needs replacing.
Bolt does not engage/disengage during function test.	<ul style="list-style-type: none">▪ Installation error▪ Blocking element damaged	Check the installation and fitting of the blocking element and repeat the test. Replace the blocking element if this proves unsuccessful.
An interval signal is emitted during key programming.	Max. permissible number of keys (16) exceeded.	Check the correct number of keys.

Diagnostics options on the open control unit

Yellow LED	Status	Required action
Off	System is OK	None
On	Electronic defect.	Switch the power supply off and then back on. Replace the control unit if the LED is still activated.
1 flash	Bolt will not engage	Check that the blocking element and bolt-hole are correctly installed.
2 flashes	Antenna malfunction	<ul style="list-style-type: none">▪ Check that the reader is connected correctly.▪ Switch the power supply off and then back on. Replace the reader if the LED continues to flash.

Operating Problems During Normal Operation

Problem	Possible cause(s)	Elimination
Area cannot be armed (reader does not react).	<ul style="list-style-type: none">▪ Key outside of scanner range.▪ Key not held up to the reader for long enough.▪ Key button not pressed when key was held up to the reader.▪ Metal objects located between key and reader.	Repeat the arming process after removing any of the possible causes of errors.
Area cannot be armed (reader emits 5 second interval signal).	<ul style="list-style-type: none">▪ Doors or windows open.▪ In the case of multiple block type lock areas: arming sequence not adhered to.	Repeat the arming process after removing any of the possible causes of errors.
Area cannot be disarmed (reader does not react).	<ul style="list-style-type: none">▪ Key outside of scanner range.▪ Key not held up to the reader for long enough.▪ Key button not pressed when key was held up to the reader.▪ Metal objects located between key and reader.	Repeat the arming process after removing any of the possible causes of errors.
Door will not open despite correct disarming procedure.	Bolt is stuck (door could be slightly warped).	Gently jolt the door, then arm and disarm the system. If this proves unsuccessful, the door will have to be pushed/pulled open with force (predetermined breaking point in the blocking element will break, the door will not be damaged).

Fault Elimination

Replacing the Bolt in the Blocking Element

(for instance, if the bolt is broken or cannot be moved)

The bolt can be replaced while the system is running (disarmed status).

Consult the appropriate installation notes and proceed as follows:

1. Uncover the blocking element by removing the plastic cover from the bolt part (for door mounting) or the collar (built-in version). For door-mounted elements, the magnetic contact housing may also have to be removed.
2. Loosen the screws on the blocking element (1) and remove the cover.
3. Lift the motor screw (2) slightly to release the bolt (3) from the gear installation.
4. Extract the bolt.
5. Replace with a new bolt.
6. Place the motor back in its original position.
7. Replace the cover and tighten the screws.
8. Install the blocking element according to the installation notes.

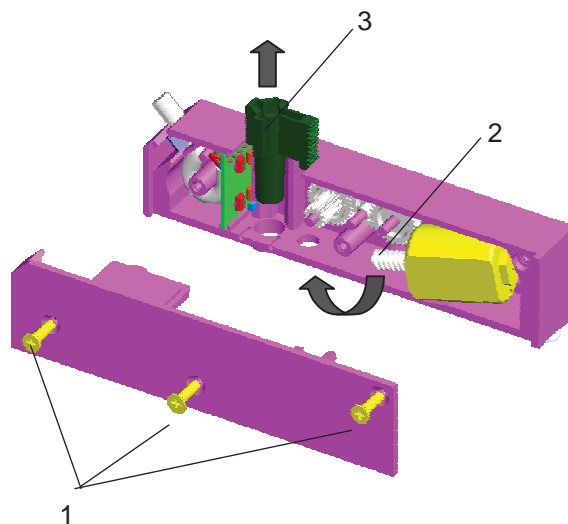

Notes for Maintenance and Service

General Information

Maintenance and inspection measures must be performed at specific intervals by appropriately qualified personnel. Furthermore, the regulations of DIN VDE 0833 apply to all related work.

Inspection and Maintenance

- Function test of the control unit device function
- Visual inspection of mounting/damage
- Function test of the blocking element

Function test of the blocking element with control unit (tamper contact open):

1. On the control unit, remove the jumper from BR1 and plug it into BR3.
 - ➔ The blocking element bolt engages.
 - ➔ The red and green LEDs on the reader light up.
 - ➔ The reader buzzer sounds for 5 seconds.
2. On the control unit, remove the jumper from BR3.
 - ➔ The blocking element bolt disengages.
 - ➔ The red and green LEDs on the reader go off.
3. Repeat steps 1 - 2 with the door closed to check the precise insertion of the blocking element's bolt into the bolt-hole.
4. Plug the jumper back to BR1 on the control unit once you have completed the function test.
 - ➔ The yellow LED on the control unit's circuit board indicates the system's status as follows:

Yellow LED	Status	Required action
Off	System is OK	None
1 flash	Bolt will not engage	<ul style="list-style-type: none">▪ Check that the blocking element and bolt-hole are correctly installed and connected to the power supply.▪ Repeat the test.

Notes for Maintenance and Service

Loss of Keys

If a key is lost, take the following steps:

1. For security reasons, erase all remaining keys and the individual customer code, i.e. restore the default settings
 - see chapter "Restoring the Default Settings"
2. Read in the security card or standard key and all the remaining keys from scratch
 - see chapter "Programming for Operation"
3. Order a new key
 - see chapter "Ordering Additional Keys"

Loss of the Security Card

Losing the security card will not compromise system functionality. However, if at some stage in the future you need further keys, you will have to request both a new security card **and** new keys from the manufacturer.

The following steps are required once you have received the new security card and keys:

1. Restore the default settings
 - see chapter "Restoring the Default Settings"
2. Read in the new security card and keys
 - see chapter "Programming for Operation"

Ordering Additional Keys

If you need new keys (e.g. for new members of staff), take the following steps:

Keys with a security card

Send your order to the manufacturer together with the security card so that the new keys can be registered on the card.

- When you receive the new keys, read them into the system as described in the chapter "Programming for Operation". You do **not** have to read in the security card again.

Standard key (without security card):

Order additional standard keys.

- When you receive the keys, read each standard key into the system as described in the chapter "Programming for Operation".

Restoring the Default Settings

1. The system is in a disarmed state (e.g. in revision mode).
2. The control unit cover has been removed.
3. In the control unit, move the jumper from BR1 to BR2.
4. Close the tamper contact GK for at least 3 seconds until the yellow LED is deactivated and the buzzer sounds.
 - ➔ All the keys and the customer code have now been erased. The default settings have been restored.
5. In the control unit, move the jumper from BR2 back to BR1.

Technical Data

SE 100 GLT control unit

Operating voltage	10.8 V ... 30 V
Total current consumption incl. blocking element and reader	
- Restore armed	53 mA
- Restore disarmed	68 mA
- When being engaged	140 mA for 300 ms
- When blocking	200 mA for 200 ms
Environmental conditions	
- Environmental class	2
- Protective system	IP 30
- Operating temperature	-5°C...+45°C
- Storage temperature	-40°C...+85°C
Housing	
- Material	ABS
- Color	RAL 9002
Dimensions (WxHxD)	135 x 160 x 35 mm
Weight	0.25 kg
VdS approval (Cl. C) for overall system	G 106067, C

Blocking element

Max. distance between bolt and counterpart	4 mm
Bolt break force	ca. 1kN
Cable to control unit	max. 6 m, 6-pin, screened, completely sealed
Environmental conditions	
- Environmental class	3
- Protective system	IP 44
- Operating temperature	-25°C...+55°C
- Storage temperature	-40°C...+85°C
Housing	
- Material	ABS
- Color	RAL 9002
Weight	
- Surface mounted models	0.45 Kg
- Recessed mounted models	0.40 Kg
Dimensions (WxHxD)	118 x 28 x 16 mm



125 kHz
0.029 uW (-10 dBuA/m)

Reader

Range	Max. 20 mm
Frequency	125 kHz
Transmission power	250 mW
Cable to control unit	max. 6 m, 6-pin, screened, completely sealed
Environmental conditions	
- Environmental class	3
- Protective system	IP 65
- Operating temperature	-25°C...+70°C
- Storage temperature	-40°C...+85°C
Housing	
- Material	ASA Luran S
- Color	Titanium white (cp. RAL 9010)
Dimensions (WxHxD)	80 x 80 x 30 mm
For installation in 55 mm surface-mount/recessed-mount junction boxes	
Weight	0.35 Kg

Key

Range	max. 20 mm
Environmental conditions	
- Environmental class	4
- Protective system	IP 67
- Operating temperature	-40°C...+70°C
- Storage temperature	-40°C...+85°C
Housing	
- Material	POM
- Color	RAL 9005 (black)
Dimensions (WxHxD)	27 x 24 x 6 mm
Weight	0.011 kg

Laws/Standards/Directives

The system fulfills all the requirements of the relevant laws, standards and directives, in particular those of

- EN 61000-6-3
- EN 50130-4
- DIN VDE 0833, Parts 1 and 3
- VdS 2110
- VdS 2227
- VdS 2119
- VdS 2311
- VdS 2203
- VdS 2252

Bosch Security Systems

For more information, please see the following web site

www.bosch-sicherheitssysteme.de

Bosch Sicherheitssysteme GmbH
Robert-Bosch-Ring 5
85630 Grasbrunn
Germany

F.01U.025.017
A2 04.2017



BOSCH